

Test Report

Test Report No.: 26820022

Issue Date: 28/06/16(DD/MM/YY)

Client Information:

Supplier No. : S1653
Client Company Name : Acetrikes Bicycle (Taicang) Co., Ltd
Contact Address : No.168, Middle Zhenghe Rd, Ludu Town, Taicang City, Jiangsu Province
Client Contact Person : Joyce Wei
IKEA Contacts Person : Abdelhak Ayadi
Sample Receive Date/Test Start Date: 05/04/16

Sample information by applicant:

Article No. : /
Article Name : /
Article Date Stamp : /
Material Producer : AIKEMA ELECTRIC(Suzhou)Co.,LTD
Material Description : motor
Material Batch Number/Production Date: 2016-3-10
Test type : Verifying Test
Identification Code : 100SX 36V
Additional Information : Tests performed for IKEA supplier 22833



Test Method:

Pb/Cd/Hg/Cr VI Content acc. to IOS-PRG-0027
RoHS Project acc. to IOS-PRG-0027
PBB and PBDE acc. to IOS-PRG-0027
Flame retardants acc. to IOS-PRG-0027, Chlorinated paraffins, C10-C13



Tony Watson
ITTC General Manager

*The test results exclusively relate to the samples under test.
The test report shall not be reproduced except in full, without the written approval of our laboratory.*



No.399, Gangwen Road, Fengxian District Shanghai, China 201413
Tel: (86-21) 3755 4800 Fax: (86-21) 3755 4819

Contents:	Page
Overall Evaluation	3
Bill of Materials (BOM)	3-5
Test Results and Description of Test Method	
Description of Test Method	5
(A)Restriction of Hazardous Substances Directive (RoHS)	5-8
(B) Short Chain of Chlorinated Paraffins (Alkanes C10-13,chloro, SCCP)	8-9
Annex	
(A)IKEA Specification IOS-PRG-0027: AA-224712-5	10
(B)Exemptions in RoHS Directive 2011/65/EU (29M+1C)	10-14
Exploding photo(s) (4 pages)	15-18

See details in next pages

Overall Evaluation

Restriction of Hazardous Substances Directive (RoHS): Lead (Pb), Cadmium (Cd), Mercury (Hg), Hexavalent Chromium (Cr VI), Polybrominated Biphenyls (PBB) and Polybrominated Diphenylethers (PBDE) are Met specification of IOS-PRG-0027: AA-224712-5

Based on the randomly sampled examinations performed, the test specimen corresponds to above specification. With regard to the parameters tested, the IKEA specification, Electrical components and products, chemical requirements, the IKEA bans and restrictions on certain chemical compounds and substances for electrical articles, including all components therein, due to national or international regulations (including the EU RoHS-directive 2011/65/EU (29M+1C))

Short Chain of Chlorinated Paraffins (Alkanes C10-13, chloro, SCCP) are met specification of IOS-PRG-0027: AA-224712-5

Bill of Materials (BOM)

Sample ID	Item No.	Components Name	Components Manufacturer	Homogenous Materials		Type/Model of Materials	Color	Same Material
1	---	Screw On End Cover	---	Y	Metal	---	Silvery	---
2	---	Nut	---	Y	Metal	---	Silvery	Same as 26832808 No.001
3	---	Washer	---	Y	Metal	---	Silvery	Same as 26830222 No.001
4	---	End Cover	---	Y	Aluminum	ADC12	Silvery	---
5	---	Hub Shell	---	Y	Aluminum	ADC12	Silvery	---
6	---	Screw On Inner Cap	---	Y	Metal	---	Silvery	---
7	---	Inner Cap	---	Y	Aluminum	ADC12	Silvery	---
8	---	Screw On Outer Half Shaft	---	Y	Metal	---	Silvery	---
9	---	Outer Half Shaft	---	Y	Iron	---	Black	---
10	---	Screw On PCB	---	Y	Metal	---	Silvery	---
11-1	---	Half Of Circuit Board	---	Y	PCB	---	Green	---
11-2	---			Y	Solder	---	Silvery	Same as 26830221 No.001
11-3	---			Y	Ceramic/Metal	---	Brown	---
11-4	---			Y	Plastic/Metal	---	Black	---
11-5	---			Y	Glue	---	Transparent	---
12	---	Motor Lube Oil	---	Y	Grease	---	Transparent	---
13	---	Nylon Gear	---	Y	MC Nylon	---	Beige	---
14	---	Inner Half Shaft	---	Y	Iron	---	Black	---
15	---	Spacer	---	Y	Metal	---	Silvery	---
16-1	---	Stator	---	Y	Metal	---	Silvery	---
16-2		Lamination		Y	Metal	---	Silvery	---

Sample ID	Item No.	Components Name	Components Manufacturer	Homogenous Materials		Type/Model of Materials	Color	Same Material
17	---	Spacer	---	Y	Metal	---	Silvery	---
18	---	Ball Holder	---	Y	Cu-alloy	---	Golden	---
19	---	Ball	---	Y	Metal	---	Silvery	---
20	---	Gear Case	---	Y	Aluminum	ADC12	Silvery	---
21	---	Plastic Washer	---	Y	Plastic	---	Pink	---
22	---	Annular Gear	---	Y	Iron	---	Silvery	---
23	---	Screw On Star Wheel	---	Y	Metal	---	Silvery	---
24	---	Star Wheel	---	Y	Iron	---	Silvery	---
25	---	Rubber Ring	---	Y	Rubber	---	Black	---
26	---	Stopper	---	Y	Metal	---	Silvery	---
27	---	Spring	---	Y	Metal	---	Black	---
28	---	Jump Ring	---	Y	Metal	---	Black	---
29	---	Stator Fixation	---	Y	Metal	---	Silvery	---
30	---	Sun Wheel	---	Y	Metal	---	Silvery	---
31	---	Magnetic Steel	---	Y	Magnet	---	Silvery	---
32	---	Silicon Steel Sheet	---	Y	Steel	---	Silvery	---
33-1	---	Stator	---	Y	Plastic Rope	---	White	---
33-2				Y	Plastic	---	White	---
33-3				Y	Plastic Sleeve	---	White	---
33-4				Y	Plastic	---	White	---
33-5				Y	Steel	---	Silvery	---
33-6				Y	Wire	---	Golden	---
33-7				Y	Plastic	---	Green	---
33-8				Y	Plastic	---	Yellow	---
34-1	---	Bearing	---	Y	Rubber	Rubber	Black	---
34-2				Y	Outer Ring	Metal	Silvery	---
34-3				Y	Ball Holder	Metal	Silvery	---
34-4				Y	Cover	Metal	Silvery	---
34-5				Y	Ball	Metal	Silvery	---
34-6				Y	Inner Ring	Metal	Silvery	---
35	---	Washer On Inner Cap	---	Y	Rubber	---	Black	---
36-1	---	Motor Parts	---	Y	Connector	Plastic	White	---
36-2				Y	Connector	Plastic	Black	---

Sample ID	Item No.	Components Name	Components Manufacturer	Homogenous Materials		Type/Model of Materials	Color	Same Material
36-3				Y	Cap	Rubber	Black	---
36-4	---	Motor Parts	---	Y	Washer	Metal	Silvery	Same as 26830220 No.001
36-5	Y			Nut	Metal	Silvery	---	
37-1	---			Connecting Line	---	Y	Spring	
37-2		Y	Clip			Plastic	Black	---
37-3		Y	Cap			Plastic	White	---
37-4		Y	Plug			PVC	Black	---
37-5		Y	Cable			PVC	Black	---
37-6		Y	Pin Holder			Plastic	Black	---
37-7		Y	Pin			Metal	Golden	---
38-1	---	Wire	---	Y	Cable	PE	White	---
38-2				Y	Cable	PE	Red	---
38-3				Y	Cable	PE	Black	---
38-4				Y	Cable	PVC	Yellow	---
38-5				Y	Cable	PVC	Green	---
38-6				Y	Cable	PVC	Blue	---
38-7				Y	Connector	Metal	Silvery	---
38-8				Y	Sleeve	Rubber	Transparent	---
38-9				Y	Wire	Metal	Silvery	---

Remark:

The result of sample "2" is copied from report 26832808 sample "001".

The result of sample "3" is copied from report 26830222 sample "001".

The result of sample "11-2" is copied from report 26830221 sample "001".

The result of sample "36-4" is copied from report 26830220 sample "001".

Same materials are based on Self-Declaration.

Description of Test Method

- (A) Determination of Lead (Pb), Cadmium (Cd), Mercury (Hg), Hexavalent Chromium (Cr VI), Polybrominated Biphenyls (PBB) and Polybrominated Diphenylethers (PBDE) in IEC 62321 by XRF, ICP/OES and GC/MS.
- (B) Short Chain of Chlorinated Paraffins (Alkanes C10-13, chloro, SCCP): Wet Chemical Test, Extraction and Followed by GC/MS/ECD

(A) Restriction of Hazardous Substances Directive (RoHS)

No.	XRF Result, mg/kg					Chemical Confirmation Result, mg/kg					
	Pb	Cd	Hg	Cr	Br	Pb	Cd	Hg	Cr VI	PBB	PBDE

No.	XRF Result, mg/kg					Chemical Confirmation Result, mg/kg					
	Pb	Cd	Hg	Cr	Br	Pb	Cd	Hg	Cr VI	PBB	PBDE
1	BL	BL	BL	---	---	---	---	---	Negative ($<0.10 \mu\text{g}/\text{cm}^2$)	---	---
2	BL	BL	BL	---	---	---	---	---	Negative ($<0.10 \mu\text{g}/\text{cm}^2$)	---	---
3	BL	BL	BL	---	---	---	---	---	Negative ($<0.10 \mu\text{g}/\text{cm}^2$)	---	---
4	BL	BL	BL	---	---	---	---	---	---	---	---
5	BL	BL	BL	---	---	---	---	---	---	---	---
6	BL	BL	BL	---	---	---	---	---	Negative ($<0.10 \mu\text{g}/\text{cm}^2$)	---	---
7	BL	BL	BL	---	---	---	---	---	---	---	---
8	BL	BL	BL	---	---	---	---	---	Negative ($<0.10 \mu\text{g}/\text{cm}^2$)	---	---
9	BL	BL	BL	---	---	---	---	---	---	---	---
10	BL	BL	BL	---	---	---	---	---	Negative ($<0.10 \mu\text{g}/\text{cm}^2$)	---	---
11-1	BL	BL	BL	BL	X	---	---	---	---	<10	<10
11-2	BL	BL	BL	---	---	---	---	---	---	---	---
11-3	BL	BL	BL	X	---	---	---	---	<10	---	---
11-4	BL	BL	BL	BL	X	---	---	---	---	<10	<10
11-5	BL	BL	BL	BL	BL	---	---	---	---	---	---
12	BL	BL	BL	BL	BL	---	---	---	---	---	---
13	BL	BL	BL	BL	BL	---	---	---	---	---	---
14	BL	BL	BL	---	---	---	---	---	Negative ($<0.10 \mu\text{g}/\text{cm}^2$)	---	---
15	BL	BL	BL	---	---	---	---	---	Negative ($<0.10 \mu\text{g}/\text{cm}^2$)	---	---
16-1	BL	BL	BL	---	---	---	---	---	Negative ($<0.10 \mu\text{g}/\text{cm}^2$)	---	---
16-2	BL	BL	BL	---	---	---	---	---	Negative ($<0.10 \mu\text{g}/\text{cm}^2$)	---	---
17	BL	BL	BL	---	---	---	---	---	Negative ($<0.10 \mu\text{g}/\text{cm}^2$)	---	---
18	BL	BL	BL	---	---	---	---	---	---	---	---
19	BL	BL	BL	---	---	---	---	---	Negative ($<0.10 \mu\text{g}/\text{cm}^2$)	---	---
20	BL	BL	BL	---	---	---	---	---	---	---	---
21	BL	BL	BL	BL	BL	---	---	---	---	---	---
22	BL	BL	BL	---	---	---	---	---	Negative ($<0.10 \mu\text{g}/\text{cm}^2$)	---	---

No.	XRF Result, mg/kg					Chemical Confirmation Result, mg/kg					
	Pb	Cd	Hg	Cr	Br	Pb	Cd	Hg	Cr VI	PBB	PBDE
23	BL	BL	BL	---	---	---	---	---	Negative ($<0.10 \mu\text{g}/\text{cm}^2$)	---	---
24	BL	BL	BL	---	---	---	---	---	Negative ($<0.10 \mu\text{g}/\text{cm}^2$)	---	---
25	BL	BL	BL	BL	BL	---	---	---	---	---	---
26	BL	BL	BL	---	---	---	---	---	Negative ($<0.10 \mu\text{g}/\text{cm}^2$)	---	---
27	BL	BL	BL	---	---	---	---	---	---	---	---
28	BL	BL	BL	---	---	---	---	---	---	---	---
29	BL	BL	BL	---	---	---	---	---	Negative ($<0.10 \mu\text{g}/\text{cm}^2$)	---	---
30	BL	BL	BL	---	---	---	---	---	Negative ($<0.10 \mu\text{g}/\text{cm}^2$)	---	---
31	BL	BL	BL	---	---	---	---	---	---	---	---
32	BL	BL	BL	---	---	---	---	---	Negative ($<0.10 \mu\text{g}/\text{cm}^2$)	---	---
33-1	BL	BL	BL	BL	BL	---	---	---	---	---	---
33-2	BL	BL	BL	BL	BL	---	---	---	---	---	---
33-3	BL	BL	BL	BL	BL	---	---	---	---	---	---
33-4	BL	BL	BL	BL	BL	---	---	---	---	---	---
33-5	BL	BL	BL	---	---	---	---	---	Negative ($<0.10 \mu\text{g}/\text{cm}^2$)	---	---
33-6	BL	BL	BL	---	---	---	---	---	---	---	---
33-7	BL	BL	BL	BL	BL	---	---	---	---	---	---
33-8	BL	BL	BL	BL	X	---	---	---	---	<10	<10
34-1	BL	BL	X	BL	BL	---	---	<5	---	---	---
34-2	BL	BL	BL	---	---	---	---	---	Negative ($<0.10 \mu\text{g}/\text{cm}^2$)	---	---
34-3	BL	BL	BL	---	---	---	---	---	Negative ($<0.10 \mu\text{g}/\text{cm}^2$)	---	---
34-4	BL	X	BL	---	---	---	<5	---	Negative ($<0.10 \mu\text{g}/\text{cm}^2$)	---	---
34-5	BL	BL	BL	---	---	---	---	---	Negative ($<0.10 \mu\text{g}/\text{cm}^2$)	---	---
34-6	BL	BL	BL	---	---	---	---	---	Negative ($<0.10 \mu\text{g}/\text{cm}^2$)	---	---
35	BL	BL	BL	BL	BL	---	---	---	---	---	---
36-1	BL	BL	BL	BL	BL	---	---	---	---	---	---
36-2	BL	BL	BL	BL	X	---	---	---	---	<10	<10
36-3	BL	BL	BL	BL	BL	---	---	---	---	---	---

No.	XRF Result, mg/kg					Chemical Confirmation Result, mg/kg					
	Pb	Cd	Hg	Cr	Br	Pb	Cd	Hg	Cr VI	PBB	PBDE
36-4	BL	BL	BL	---	---	---	---	---	Negative ($<0.10 \mu\text{g}/\text{cm}^2$)	---	---
36-5	BL	BL	BL	---	---	---	---	---	Negative ($<0.10 \mu\text{g}/\text{cm}^2$)	---	---
37-1	BL	BL	BL	---	---	---	---	---	Negative ($<0.10 \mu\text{g}/\text{cm}^2$)	---	---
37-2	BL	BL	BL	BL	BL	---	---	---	---	---	---
37-3	BL	BL	BL	BL	BL	---	---	---	---	---	---
37-4	BL	BL	BL	BL	BL	---	---	---	---	---	---
37-5	BL	BL	BL	BL	BL	---	---	---	---	---	---
37-6	BL	BL	BL	BL	BL	---	---	---	---	---	---
37-7	BL	BL	BL	---	---	---	---	---	Negative ($<0.10 \mu\text{g}/\text{cm}^2$)	---	---
38-1	BL	BL	BL	BL	BL	---	---	---	---	---	---
38-2	BL	BL	BL	BL	BL	---	---	---	---	---	---
38-3	BL	BL	BL	BL	BL	---	---	---	---	---	---
38-4	BL	BL	BL	BL	BL	---	---	---	---	---	---
38-5	BL	BL	BL	BL	BL	---	---	---	---	---	---
38-6	BL	BL	BL	BL	BL	---	---	---	---	---	---
38-7	BL	BL	BL	---	---	---	---	---	Negative ($<0.10 \mu\text{g}/\text{cm}^2$)	---	---
38-8	BL	BL	BL	BL	BL	---	---	---	---	---	---
38-9	BL	BL	BL	---	---	---	---	---	---	---	---

(B) Short Chain of Chlorinated Paraffins (Alkanes C10-13, chloro, SCCP)

No.	Chemical Confirmation Result, mg/kg
37-4	<300
37-5	<300
38-4	<300
38-5	<300
38-6	<300

Remark:

(A) Limits of screening test by XRF for Regulated Elements in Various Materials

Materials	Pb	Cd	Hg	Cr	Br
Metal	$\text{BL} \leq 500 < X < 1500 \leq \text{OL}$	$\text{BL} \leq 50 < X < 150 \leq \text{OL}$	$\text{BL} \leq 50 < X < 150 \leq \text{OL}$	---	---

Materials	Pb	Cd	Hg	Cr	Br
Plastic and Other Polymeric	BL ≤150<X<450≤OL	BL ≤50<X<150≤OL	BL ≤50<X<150≤OL	BL ≤500<X	BL ≤500<X
Ceramics and Glass	BL ≤500<X<1500≤OL	BL ≤50<X<150≤OL	BL ≤50<X<150≤OL	BL ≤500<X	---
Surface Coating	BL ≤500<X<1500≤OL	BL ≤50<X<150≤OL	BL ≤50<X<150≤OL	BL ≤500<X	BL ≤500<X
Electronic Components including PCB	BL ≤500<X<1500≤OL	BL ≤50<X<150≤OL	BL ≤50<X<150≤OL	BL ≤500<X	BL ≤500<X
Other Materials	BL ≤150<X<450≤OL	BL ≤50<X<150≤OL	BL ≤50<X<150≤OL	BL ≤500<X	BL ≤500<X

(B) Wet chemistry test methods

Testing Item	Testing Method
Pb, Cd, Cr	With Reference to IEC 62321-5:2013
Hg	With Reference to IEC 62321-4:2013
Cr VI (for non-metal)	With Reference to IEC 62321:2008
Cr VI (for metal)	With Reference to IEC 62321-7-1:2015
PBB, PBDE	With Reference to IEC 62321-6:2015

Remark:

- (a) "Below limit" (BL) or "Over limit" (OL) determination is set at 50% less than or greater than IKEA limit, respectively.
- (b) X=Inconclusive Result, further wet chemical test is required to be performed.
- (c) "<" denotes "less than"
- (d) "---" denotes no performed items
- (e) # Limit was adjusted as below acc. to IKEA Specification IOS-PRG-0027: AA-224712-5, RoHS Directive 2011/65/EU (29M+1C), see details in Annex (B)
- (f) Negative= A negative test result indicated the concentration of Cr (VI) is less than threshold of 0.10 µg/cm² for boiling-water-extraction procedures by UV-VIS Spectrophotometer analysis. The sample coating is considered a non-Cr (VI) based coating.

Annex

(A) IKEA Specification IOS-PRG-0027: AA-224712-5

IKEA Limit, mg/kg	Pb	Cd	Hg	Cr VI	PBB, PBDE	SCCP
Metal	1000	100	100	Negative	---	---
Ceramics and Glass	1000	100	50	1000	---	---
Surface Coating	1000	100	50	1000	1000	---
Electronic Components including Printed Circuit Board	1000	100	50	1000	1000	---
Plastic and Other Polymeric	300	100	50	1000	1000	1000
Other Materials	1000	100	50	1000	1000	---

(B) Exemptions in RoHS Directive 2011/65/EU (29M+1C)

Exemption		Scope and Dates of Applicability
1	Mercury in single capped (compact) fluorescent lamps not exceeding (per burner):	
1(a)	For general lighting purposes <30W: 5 mg	Expires on 31 December 2011; 3.5 mg may be used per burner after 31 December 2011 until 31 December 2012; 2.5 mg shall be used per burner after 31 December 2012
1(b)	For general lighting purposes ≥30W and <50W: 5 mg	Expires on 31 December 2011; 3.5 mg may be used per burner after 31 December 2011
1(c)	For general lighting purposes ≥50W and <150W: 5 mg	
1(d)	For general lighting purposes ≥150W: 15 mg	
1(e)	For general lighting purposes with circular or square structural shape and tube diameter ≤17mm	No limitation of use until 31 December 2011; 7mg may be used per burner after 31 December 2011
1(f)	For special purposes: 5 mg	
1(g)	For general lighting purposes < 30 W with a lifetime equal or above 20 000 h: 3,5 mg	Expires on 31 December 2017
2(a)	Mercury in double-capped linear fluorescent lamps for general lighting purposes not exceeding (per lamp):	
2(a)(1)	Tri-band phosphor with normal lifetime and a tube diameter <9mm (e.g. T2): 5 mg	Expires on 31 December 2011; 4 mg may be used per lamp after 31 December 2011
2(a)(2)	Tri-band phosphor with normal lifetime and a tube diameter ≥ 9mm and ≤17mm (e.g. T5): 5 mg	Expires on 31 December 2011; 3 mg may be used per lamp after 31 December 2011
2(a)(3)	Tri-band phosphor with normal lifetime and a tube diameter >17mm and ≤28mm (e.g. T8): 5 mg	Expires on 31 December 2011; 3.5 mg may be used per lamp after 31 December 2011
2(a)(4)	Tri-band phosphor with normal lifetime and a tube diameter >28mm (e.g. T12): 5 mg	Expires on 31 December 2012; 3.5 mg may be used per lamp after 31 December 2012
2(a)(5)	Tri-band phosphor with long lifetime (≥25000h): 8 mg	Expires on 31 December 2011; 5 mg may be used per lamp after 31 December 2011
2(b)	Mercury in other fluorescent lamps not exceeding (per lamp):	

Exemption		Scope and Dates of Applicability
2(b)(1)	Linear halophosphate lamps with tube >28mm (e.g. T10 and T12): 10 mg	Expires on 13 April 2012
2(b)(2)	Non-linear halophosphate lamps (all diameters): 15 mg	Expires on 13 April 2016
2(b)(3)	Non-linear tri-band phosphor lamps with tube diameter >17mm (e.g. T9)	No limitation of use until 31 December 2011; 15 mg may be used per lamp after 31 December 2011
2(b)(4)	Lamps for other general lighting and special purposes (e.g. induction lamps)	No limitation of use until 31 December 2011; 15 mg may be used per lamp after 31 December 2011
3	Mercury in cold cathode fluorescent lamps and external electrode fluorescent lamps (CCFL and EEFL) for special purposes not exceeding (per lamp):	
3(a)	Short length ($\leq 500\text{mm}$)	No limitation of use until 31 December 2011; 3.5 mg may be used per lamp after 31 December 2011
3(b)	Medium length ($> 500\text{mm}$ and $\leq 1500\text{mm}$)	No limitation of use until 31 December 2011; 5 mg may be used per lamp after 31 December 2011
3(c)	Long length ($> 1500\text{mm}$)	No limitation of use until 31 December 2011; 13 mg may be used per lamp after 31 December 2011
4(a)	Mercury in other low pressure discharge lamps (per lamp)	No limitation of use until 31 December 2011; 15 mg may be used per lamp after 31 December 2011
4(b)	Mercury in High Pressure Sodium (vapour) lamps for general lighting purposes not exceeding (per burner) in lamps with improved color rendering index $R_a > 60$:	
4(b)-I	$P \leq 155\text{W}$	No limitation of use until 31 December 2011; 30 mg may be used per burner after 31 December 2011
4(b)-II	$155\text{W} < P \leq 405\text{W}$	No limitation of use until 31 December 2011; 40 mg may be used per burner after 31 December 2011
4(b)-III	$P > 405\text{W}$	No limitation of use until 31 December 2011; 40 mg may be used per burner after 31 December 2011
4(c)	Mercury in other High Pressure Sodium (vapour) lamps for general lighting purposes not exceeding (per burner):	
4(c)-I	$P \leq 155\text{W}$	No limitation of use until 31 December 2011; 25 mg may be used per burner after 31 December 2011
4(c)-II	$155\text{W} < P \leq 405\text{W}$	No limitation of use until 31 December 2011; 30 mg may be used per burner after 31 December 2011

Exemption		Scope and Dates of Applicability
4(c)-III	P>405W	No limitation of use until 31 December 2011; 40 mg may be used per burner after 31 December 2011
4(d)	Mercury in High Pressure Mercury (vapour) lamps (HPMV)	Expires on 13 April 2015
4(e)	Mercury in metal halide lamps (MH)	
4(f)	Mercury in other discharge lamps for special purposes not specifically mentioned in this Annex	
4(g)	Mercury in hand crafted luminous discharge tubes used for signs, decorative or architectural and specialist lighting and light-artwork, where the mercury content shall be limited as follows: (a) 20 mg per electrode pair + 0,3 mg per tube length in cm, but not more than 80 mg, for outdoor applications and indoor applications exposed to temperatures below 20 °C; (b) 15 mg per electrode pair + 0,24 mg per tube length in cm, but not more than 80 mg, for all other indoor applications.	Expires on 31 December 2018
5(a)	Lead in glass of cathode ray tubes	
5(b)	Lead in glass of fluorescent tubes not exceeding 0.2% by weight	
6(a)	Lead as an alloying element in steel for machining purposes and in galvanized steel containing up to 0.35% lead by weight	
6(b)	Lead as an alloying element in aluminum containing up to 0.4% lead by weight	
6(c)	Copper alloy containing up to 4% lead by weight	
7(a)	Lead in high melting temperature type solders (i.e. lead-based alloys containing 85% by weight or more lead)	
7(b)	Lead in solders for servers, storage and storage array systems, network infrastructure equipment for switching, signaling, transmission, and network management for telecommunications	
7(c)-I	Electrical and electronic components containing lead in a glass or ceramic other than dielectric ceramic in capacitors, e.g. piezoelectronic devices, or in a glass or ceramic matrix compound	
7(c)-II	Lead in dielectric ceramic in capacitors for a rated voltage of 125V AC or 250V DC or higher	
7(c)-III	Lead in dielectric ceramic in capacitors for a rated voltage of less than 125V AC or 250V DC	Expires on 1 January 2013 and after that date may be used in spare parts for EEE placed on the market before 1 January 2013
7(c)-IV	Lead in PZT based dielectric ceramic materials for capacitors which are part of integrated circuits or discrete semiconductors	Expires on 21 July 2016
8(a)	Cadmium and its compounds in one shot pellet type thermal cut-offs	Expires on 1 January 2012 and after that date may be used in spare parts for EEE placed on the market before 1 January 2012
8(b)	Cadmium and its compounds in electrical contacts	

Exemption		Scope and Dates of Applicability
9	Hexavalent chromium as an anticorrosion agent of the carbon steel cooling system in absorption refrigerators up to 0.75% by weight in the cooling solution	
9(b)	Lead in bearing shells and bushes for refrigerant-containing compressors for heating, ventilation, air conditioning and refrigeration (HVACR) applications	
11(a)	Lead used in C-press compliant pin connector systems	May be used in spare parts for EEE placed on the market before 24 September 2010
11(b)	Lead used in other than C-press compliant pin connector systems	Expires on 1 January 2013 and after that date may be used in spare parts for EEE placed on the market before 1 January 2013
12	Lead as a coating material for the thermal conduction module C-ring	May be used in spare parts for EEE placed on the market before 24 September 2010
13(a)	Lead in white glasses used for optical applications	
13(b)	Cadmium and lead in filter glasses and glasses used for reflectance standards	
14	Lead in solders consisting of more than two elements for the connection between the pins and the package of microprocessors with a lead content of more than 80 % and less than 85% by weight	Expired on 1 January 2011 and after that date may be used in spare parts for EEE placed on the market before 1 January 2011
15	Lead in solders to complete a viable electrical connection between semiconductor die and carrier within integrated circuit flip chip packages	
16	Lead in linear incandescent lamps with silicate coated tubes	Expires on 1 September 2013
17	Lead halide as radiant agent in high intensity discharge (HID) lamps used for professional reprography applications	
18(a)	Lead as activator in the fluorescent powder (1% lead by weight or less) of discharge lamps when used as speciality lamps for diazoprinting reprography, lithography, insect traps, photochemical and curing processes containing phosphors such as SMS ((Sr,Ba) ₂ MgSi ₂ O ₇ :Pb)	Expired on 1 January 2011
18(b)	Lead as activator in the fluorescent powder (1% lead by weight or less) of discharge lamps when used as sun tanning lamps containing phosphors such as BSP (BaSi ₂ O ₅ :Pb)	
19	Lead with PbBiSn-Hg and PbInSn-Hg in specific compositions as main amalgam and with PbSn-Hg as auxiliary amalgam in very compact energy saving lamps (ESL)	Expires on 1 June 2011
20	Lead oxide in glass used for bonding front and rear substrates of flat fluorescent lamps used for Liquid Crystal Displays (LCDs)	Expires on 1 June 2011
21	Lead and cadmium in printing inks for the application of enamels on glasses, such as borosilicate and soda lime glasses	
23	Lead in finishes of fine pitch components other than connectors with a pitch of 0.65 mm and less	May be used in spare parts for EEE placed on the market before 24 September 2010

Exemption		Scope and Dates of Applicability
24	Lead in solders for the soldering to machined through hole discoidal and planar array ceramic multilayer capacitors	
25	Lead oxide in surface conduction electron emitter displays (SED) used in structural elements, notably in the seal frit and frit ring	
26	Lead oxide in the glass envelope of black light blue lamps	Expires on 1 June 2011
27	Lead alloys as solder for transducers used in high-powered (designated to operate for several hours at acoustic power levels of 125Db SPL and above) loudspeakers	Expired on 24 September 2010
29	Lead bound in crystal glass as defined in Annex I (Categories 1, 2, 3 and 4) of Council Directive 69/493/EEC (1)	
30	Cadmium alloys as electrical/mechanical solder joints to electrical conductors located directly on the voice coil in transducers used in high-powered loudspeakers with sound pressure levels of 100Db (A) and more	
31	Lead in soldering materials in mercury free flat fluorescent lamps (which, e.g. are used for liquid crystal displays, design or industrial lighting)	
32	Lead oxide in seal frit used for making window assemblies for Argon and Krypton laser tubes	
33	Lead in solders for the soldering of thin copper wires of 100µm diameter and less in power transformers	
34	Lead in cermet-based trimmer potentiometer elements	
36	Mercury used as a cathode sputtering inhibitor in DC plasma displays with a content up to 30 mg per display	Expires on 1 July 2010
37	Lead in the plating layer of high voltage diodes on the basis of a zinc borate glass body	
38	Cadmium and cadmium oxide in thick film pastes used on aluminum bonded beryllium oxide	
39	Cadmium in color converting II-VI LEDs (<10µg Cd per mm ² of light-emitting area) for use in solid state illumination or display systems	Expires on 1 July 2014
40	Cadmium in photoresistors for analogue optocouplers applied in professional audio equipment	Expires on 31 December 2013
41	Lead in solders and termination finishes of electrical and electronic components and finishes of printed circuit boards used in ignition modules and other electrical and electronic engine control systems, which for technical reasons must be mounted directly on or in the crankcase or cylinder of hand-held combustion engines (classes SH:1, SH:2, SH:3 of Directive 97/68/EC of the European Parliament and of the Council (2))	Expires on 31 December 2018

Exploding Photos

Note: Sample Identifications and Photos

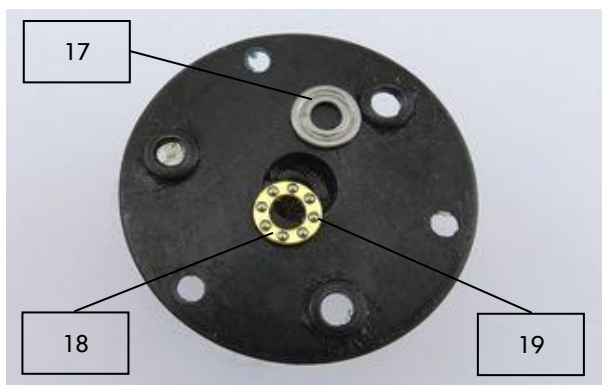
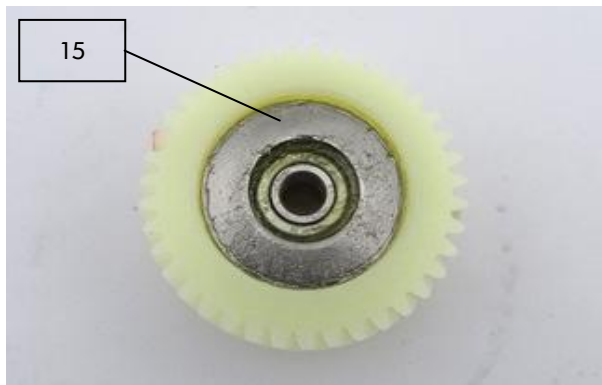
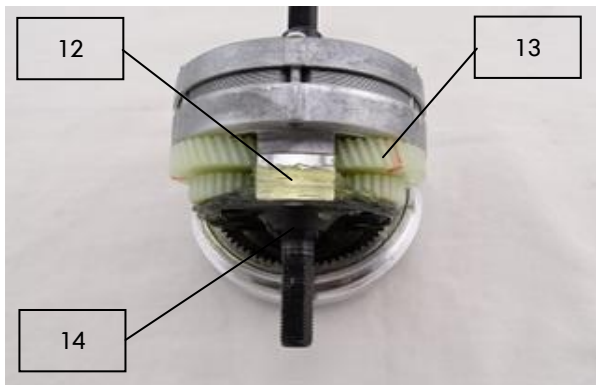
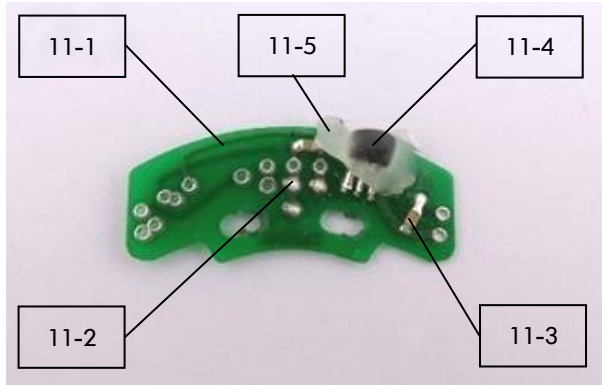
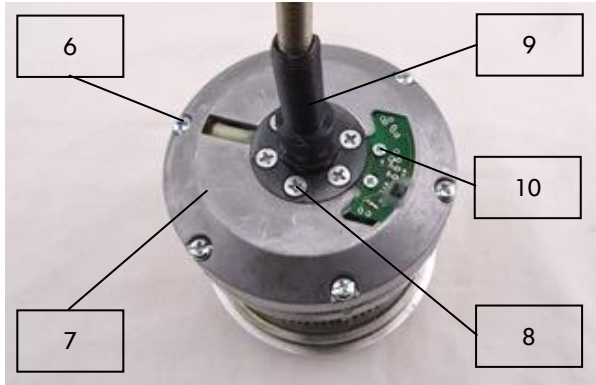
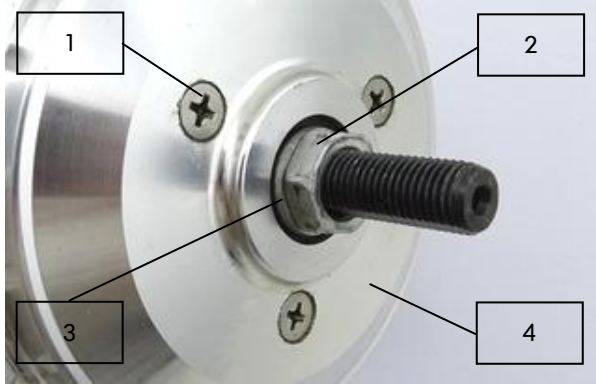

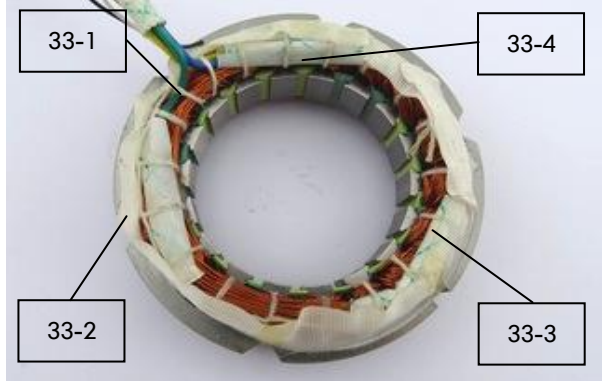
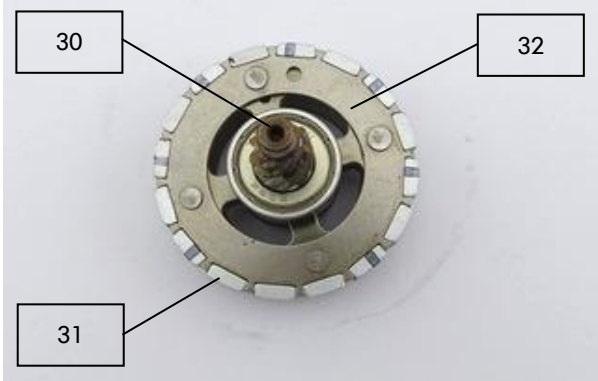
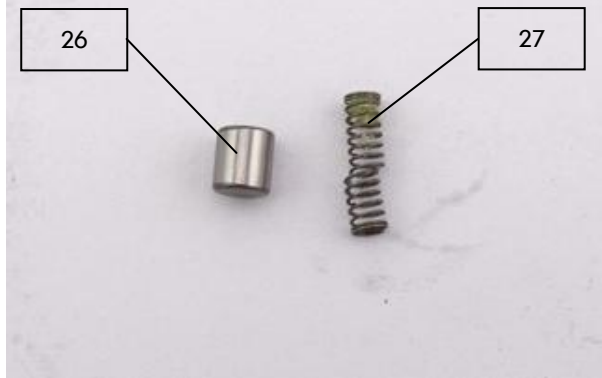
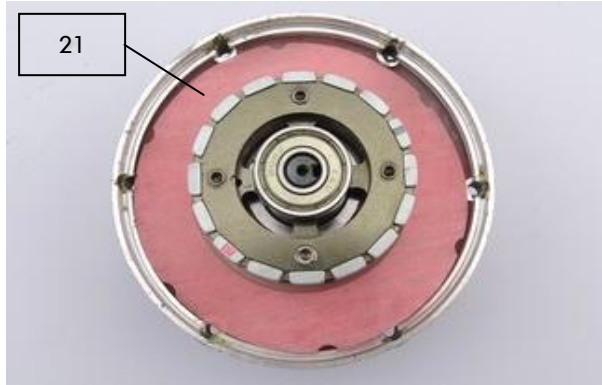

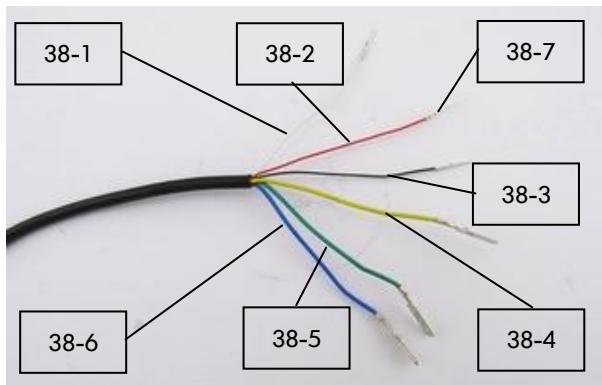
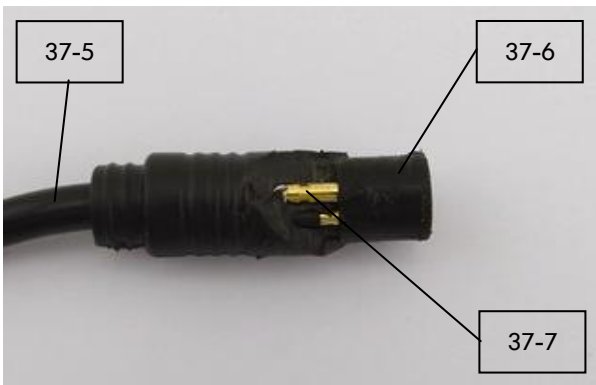
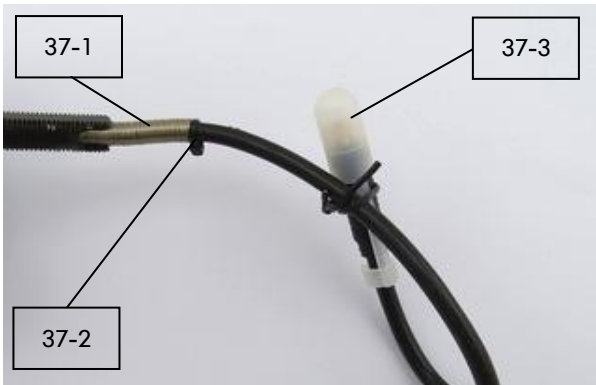
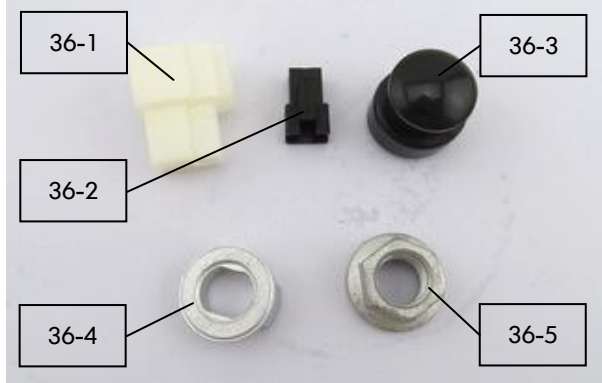
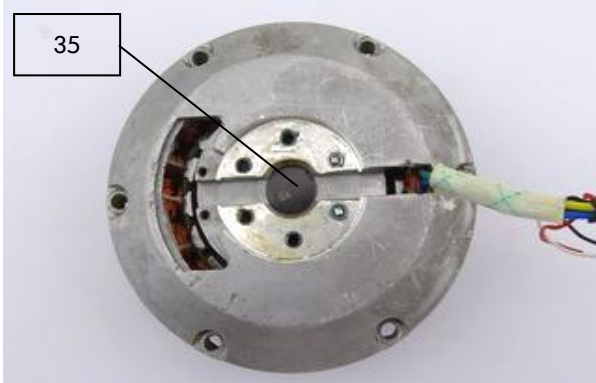

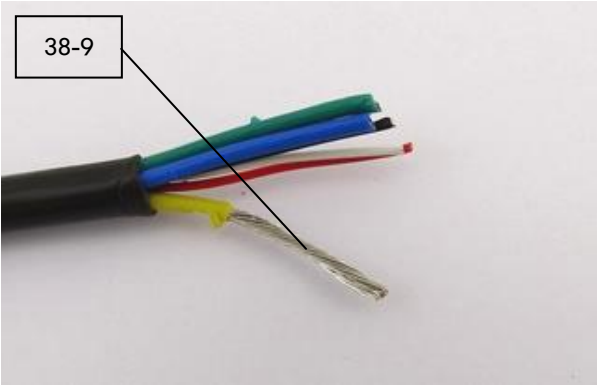
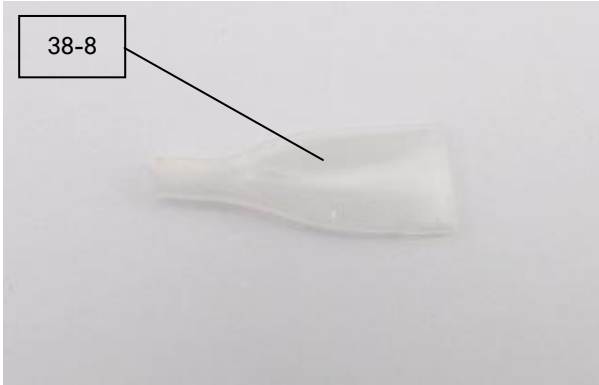

-----End of Report-----